

HUBERT

amp up your process

Datasheet

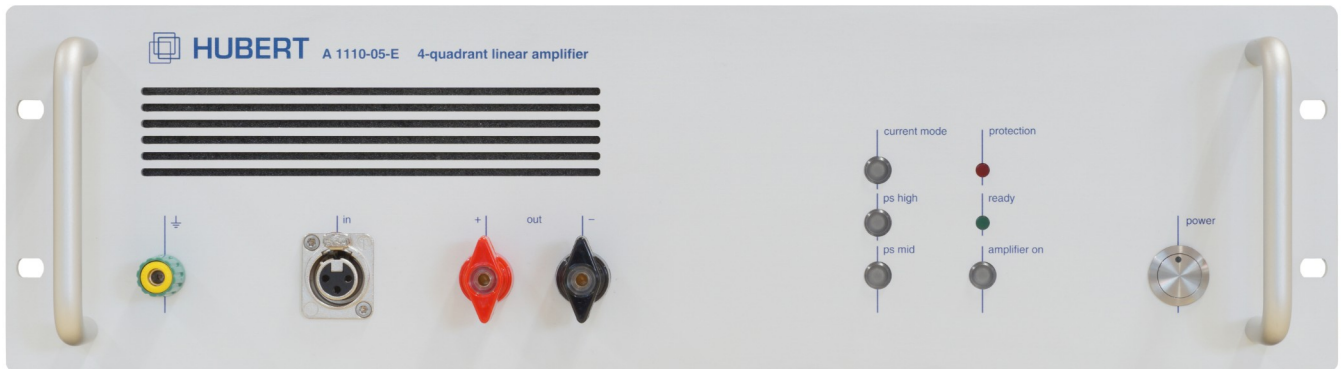

A1110-05-E

4-Quadrant Voltage and Current Amplifier
DC - 1 MHz



1 Product Description

The A1110-05-E is a linear, extreme-broadband, precision power amplifier designed for all applications which require fast-changing signals with high performance.

The A1110-05-E can be operated as a voltage amplifier or current amplifier. The current amplifier offers a constant, frequency-invariant output current for inductive loads.

Three selectable operating voltages per polarity are available for high-voltage/low-current or low-voltage/high-current applications. Voltage switching is manual. Especially for very low impedance loads, the operating voltage can be reduced to a 1/3, which results in a corresponding reduction of power dissipation.

Output voltage and output current can be limited and observed on low-impedance signal outputs.

The device is equipped with a temperature-controlled, quietly-running fan. An over-temperature disconnection, a power-loss calculation and an absolute-current monitoring guarantee perfect short-circuit and overload protection.

An interlock offers the possibility of a remote-controlled security system.

The operation is implemented over the operating elements on the front panel and over the USB interface by PC with a graphical user interface.

The device's functionality can even be extended by several product options.

Please find the latest release of this datasheet on our website:
www.drhubert.com



2 Features

- 4-quadrant voltage and current amplifier
- Fully configurable and operable by means of the supplied software
- Output voltages up to $75 V_{\text{peak}}$
- Output current up to $11 A_{\text{peak}}$
- Output current $27 A_{\text{peak}} / 500 \text{ ms}$
- Symmetrical input
- Series / parallel input connection in case of higher voltage / current requirements
- USB port as standard (LAN interface optional)
- 3 supply voltages
- Interlock
- Voltage / current monitor output
- 6 configurable compensation networks for inductive loads in current amplifier mode

3 Applications

- General lab applications for research, development and testing
- EMC testing
- Material testing
- MRI
- Component tests
- Plunger coil drives
- Piezo actuation
- Generation of magnetic fields (e.g. with Helmholtz coils)
- Medical engineering
- Laser technology
- Plasma technology



4 Control Software

The device includes an application software that ensures fully remote-controlled operation and comprehensive configuration of the amplifier via the USB interface. A trouble-free integration to existing automated test systems is guaranteed by a complete remote command list.

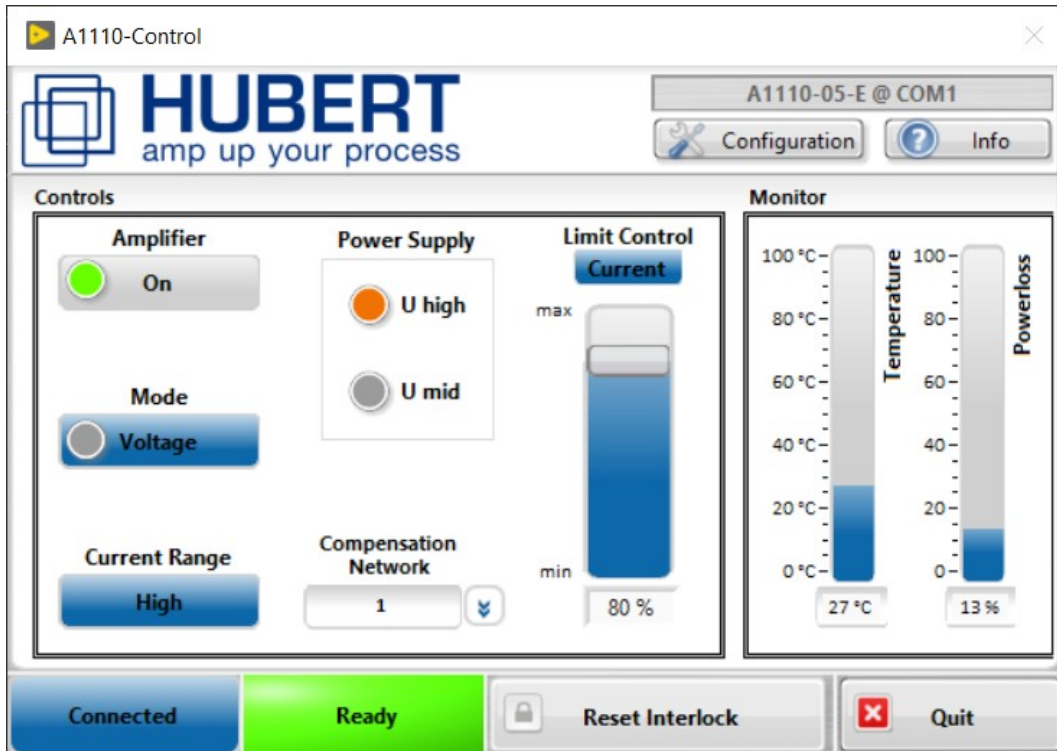

Figure 1: A1110-Control Main Menu

5 Pictures



Figure 2: Back Panel Elements



6 Current Amplifier

In current control mode, the A1110-05-E behaves like a voltage-controlled current source and delivers a nearly frequency-independent constant load current to an inductive load.

The following five compensation networks are equipped ex works.

No	Load	Rc	Cc	Current Range
1	1 Ohm + 500 uH	100 kOhm	10 nF	high
2	0,1 Ohm + 200 uH	68 kOhm	4,7 nF	high
3	1 Ohm + 1mH	150 kOhm	22 nF	high
4	4 Ohm + 1,8 mH	200 kOhm	1 nF	high
5	0,078 R + 88 uH	80 kOhm	6,8 nF	high
6	<i>Reserved for Option-01</i>			

Table 1: Compensation Networks

The selection is made by our A1110-Control software. Please also note the corresponding recommended current measuring range.

If none of the above compensation networks is suitable for your application, please order your amplifier with Option-01: Custom Current Amplifier. Our engineers will design a custom compensation network specific for your needs. Up to 6 custom compensation networks are possible as existing ones can be removed.

We would be pleased to assist you in the realization of a compensation network for your application.



7 Specifications

Parameters	Specification	Conditions/Moments
	Controlled Voltage Mode	25° C ambient temperature Continuous operation
Input Impedance	100 kOhm 200 kOhm	unbalanced, 1kHz balanced, 1kHz
Maximum Input Level	5.5 V (+14,5 dBV)	< 1 % THD, 1 kHz, 8 Ohm Load
Common-Mode Rejection Ratio	> 60 dB	Rs= 50 Ohm, 10 Hz – 200 kHz, re +34.5 dBV @ Output
Small Signal Frequency Response	DC - 200 kHz DC - 1 MHz	+0, -0.5 dB, 1 W @ 8 Ohm High Voltage Mode +0, -3.0 dB, 1 W @ 8 Ohm High Voltage Mode
Phase response	+0, -5 degrees	10 Hz - 30 kHz
Power Response (continuous)		
8 Ohm Load	400 W	DC - 30 kHz, < 1% THD High Voltage Mode
	380 W	DC – 100 kHz, < 0.5% THD High Voltage Mode
	200 W	DC – 200 kHz, < 1% THD High Voltage Mode
4 Ohm Load	220 W	DC - 30 kHz, < 0.1% THD Mid Voltage Mode
	200 W	DC - 100 kHz, < 0.1% THD Mid Voltage Mode
	180 W	DC - 200 kHz, < 0.2% THD Mid Voltage Mode
3 Ohm Load	200 W	DC – 30 kHz, < 0.1% THD Mid Voltage Mode
	180 W	DC – 100 kHz, < 0.1% THD Mid Voltage Mode
	150 W	DC – 200 kHz, < 0.1% THD Mid Voltage Mode
0.5 Ohm Load	28 W	DC – 10 kHz, < 0.15% THD Low Voltage Mode
	25 W	DC – 30 kHz, < 0.2% THD Low Voltage Mode
	18 W	DC – 100 kHz, < 0.3% THD Low Voltage Mode
	15 W	DC – 200 kHz, < 0.3% THD Low Voltage Mode
Slew Rate	80 V/μs	



Parameters	Specification	Conditions/Moments
Residual Noise		
10 Hz - 22 kHz	< 100 μ V (< -80 dBV)	All Voltage Modes Input shorted 8 Ohm Load
10 Hz - 80 kHz	< 125.5 μ V (< -78 dBV)	All Voltage Modes Input shorted 8 Ohm Load
10 Hz - 200 kHz	< 158.5 μ V (< -76 dBV)	All Voltage Modes Input shorted 8 Ohm Load
Signal-to-Noise Ratio		
10 Hz - 22 kHz	< -114.5 dB	re +34.5 dBV, < 1% THD 8 Ohm Load High Voltage Mode
10 Hz - 80 kHz	< -112.5 dB	re +34.5 dBV, < 1% THD 8 Ohm Load High Voltage Mode
10 Hz - 200 kHz	< -110.5 dB	re +34.5 dBV, < 1% THD 8 Ohm Load High Voltage Mode
THD+N		
10 Hz - 100 kHz All Voltage Modes	< 0.03 %	1 W @ 8 Ohm
Output Offset	< 1.0 mV	DC
Output Impedance	< 80 mOhm	
Power, Pulse, 40ms, 20% Duty Cycle		
Peak output		
10 Ohm	80 V, 8 A	High Voltage Mode
5 Ohm	52 V, 10.4 A	Mid Voltage Mode
4 Ohm	43 V, 10.75 A	Mid Voltage Mode
Short-Time Current, Pulse, 500ms, 5% Duty Cycle, unipolar		
Peak Output		
60 mOhm	+ 27 A	+Ulow / -Ulow
60 mOhm	- 27 A	+Ulow / -Ulow
Power, Sinus, 100Hz, continuous		
8 Ohm	57 V, 7.125 A, 406 W	< 0.3 % THD High Voltage Mode
0.25 Ohm	1.9 V, 7.6 A, 14.4 W	< 0.1% THD Low Voltage Mode
Power, DC		
10 Ohm	72 V, 7.2 A, 518 W	High Voltage Mode
5 Ohm	47 V, 9.4 A, 442 W	Mid Voltage Mode
2 Ohm	22 V, 11 A, 242 W	Low Voltage Mode
1 Ohm	11 V, 11 A, 121 W	Low Voltage Mode
0.25 Ohm	2.7 V, 10.8 A, 29.2 W	Low Voltage Mode
Sink Power, DC	150 W	Low Voltage Mode; see U/I-Plot



Parameters	Specification	Conditions/Moments
Voltage Monitor	$\pm 100 \text{ mV} \cong 1 \text{ V} \pm 0.5\%$	
Current Monitor	High Current Range: $\pm 400 \text{ mV} \cong 1 \text{ A} \pm 1\%$ Low Current Range: $\pm 1 \text{ V} \cong 100 \text{ mA} \pm 1\%$	Shunt = 10 mOhm Shunt = 2.5 Ohm
Gain		
Controlled Voltage Mode	1 V / 10 V	Uin / Uout
Controlled Current Mode	High Current Range: 1 V / 3 A Low Current Range: n.a.	Uin / Iout unspecified
Physical Characteristics		
AC Power	230 VAC / 50 Hz	
Remote control	USB Ethernet (Option)	
Operating Temperature	10 °C to 55 °C	
Humidity	80% or less	non-condensing
Cooling	Forced air	
Dimensions (W x H x D)	449 x 133 x 495 mm	
Weight	Approx. 15 kg	

The E series amplifiers are suitable for operation at three different operating voltages:

- high operating voltage ($\pm 90 \text{ V}$) for high output voltages and low load currents
- medium operating voltage ($\pm 60 \text{ V}$) for medium output voltages and medium load currents
- low operating voltage ($\pm 30 \text{ V}$) for low output voltages and high load currents

To keep the dissipation power of the amplifier at a minimum the operating voltage should always be selected corresponding to the load.



7.1 Output Voltage vs. Frequency (THD + N < 1%)

Red: @ 8 Ohm
Blue: @ 4 Ohm
Green: @ 2 Ohm

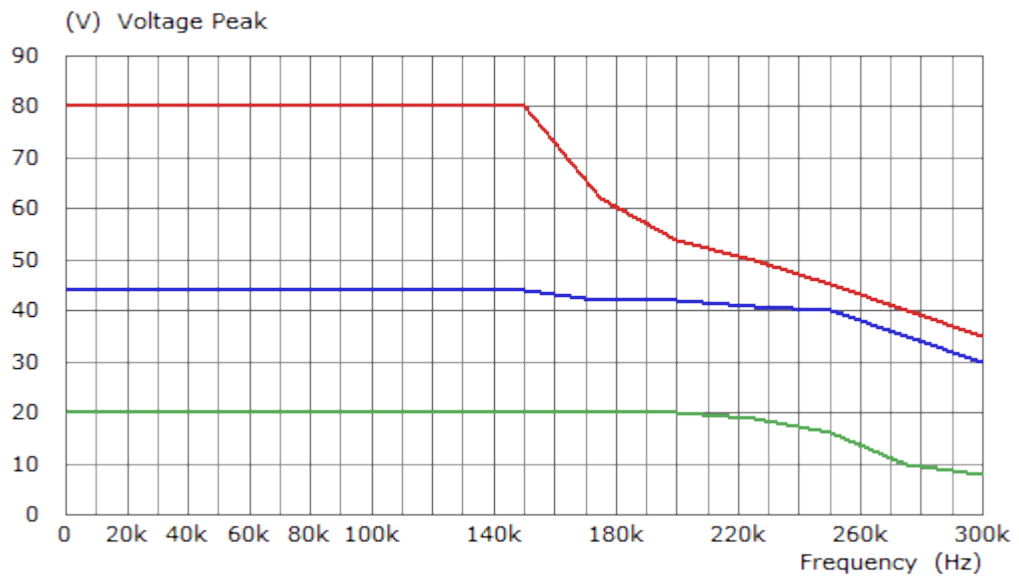

7.2 Output Current vs. Output Voltage (THD + N < 1%)

Supply Voltage: Low
Blue: AC Limit
Red: DC Limit

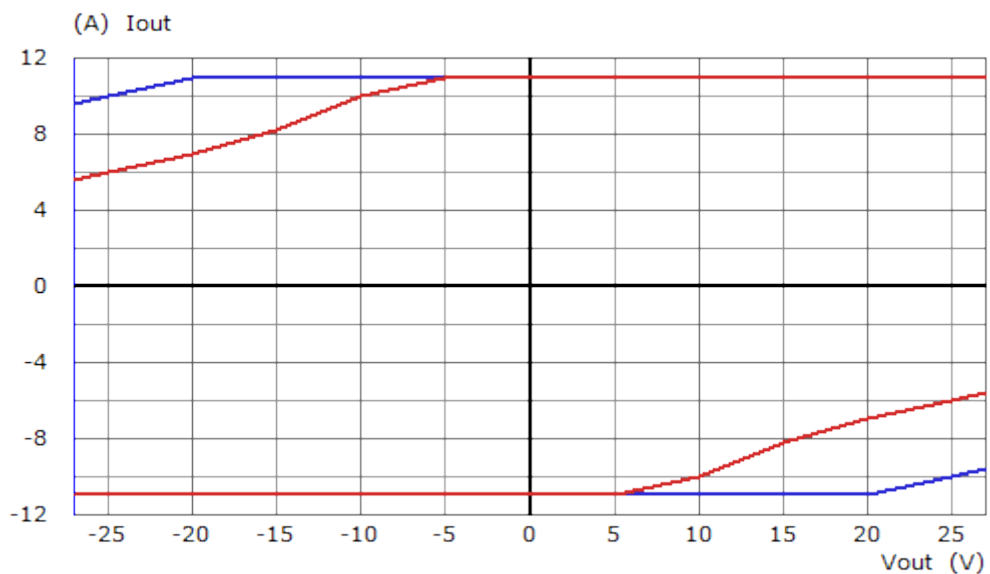



7.3 Output Current vs. Output Voltage (THD + N < 1%)

Supply Voltage: Mid
Blue: AC Limit
Red: DC Limit

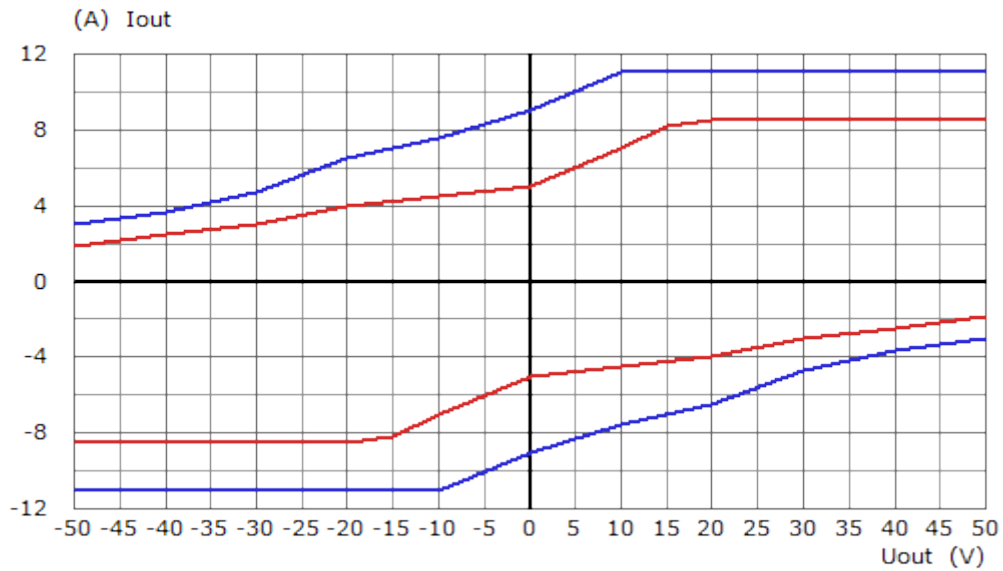

7.4 Output Current vs. Output Voltage (THD + N < 1%)

Supply Voltage: High
Blue: AC Limit
Red: DC Limit

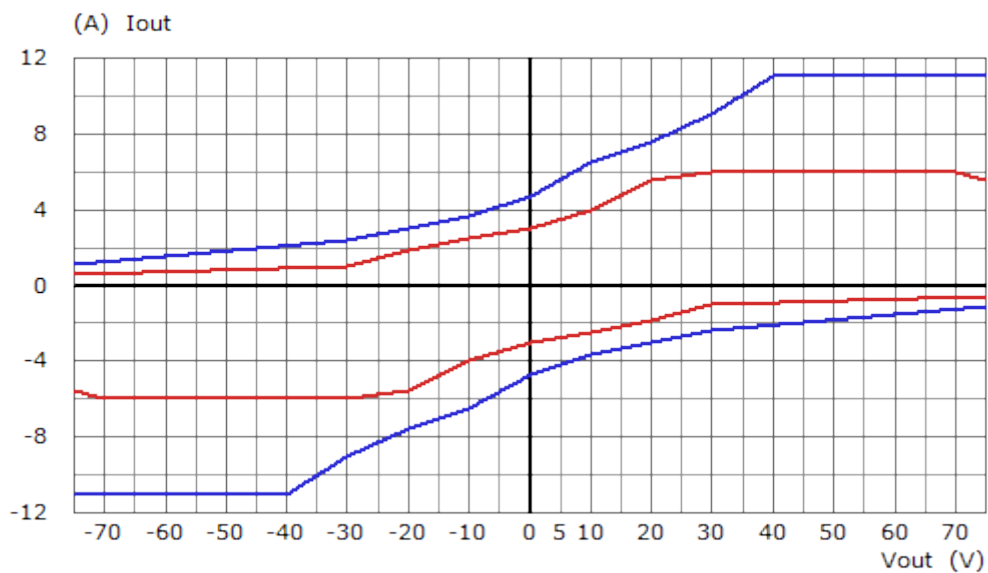



7.5 Square Wave at 100 kHz and 10 Ohm Load

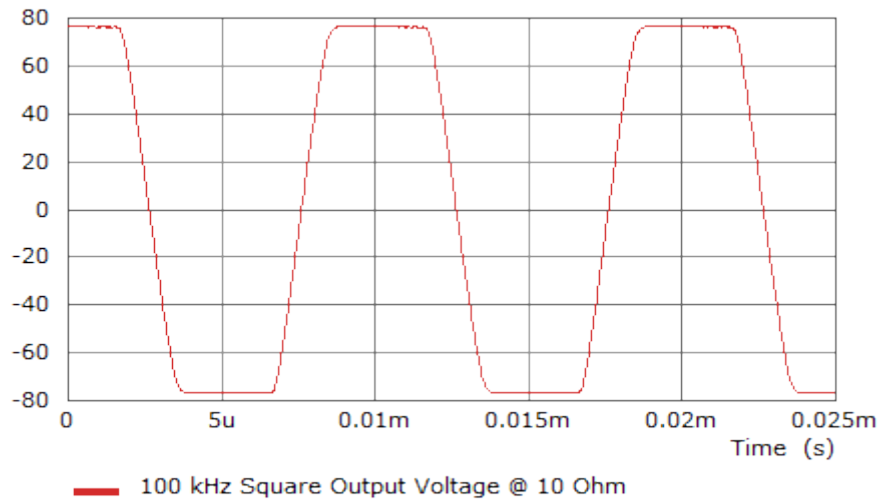

7.6 Power Bandwidth at 10 Ohm Load

Input level normalised to max. output level at 30 kHz; THD+N < 1%

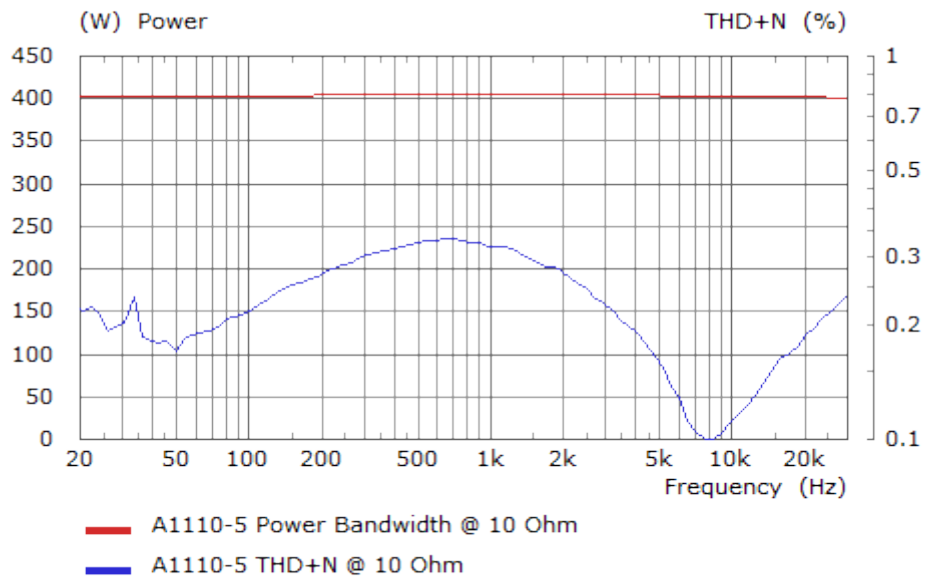



7.7 Power Bandwidth at 4 Ohm Load

Input level normalized to max. output level at 200 kHz; THD+N < 1%

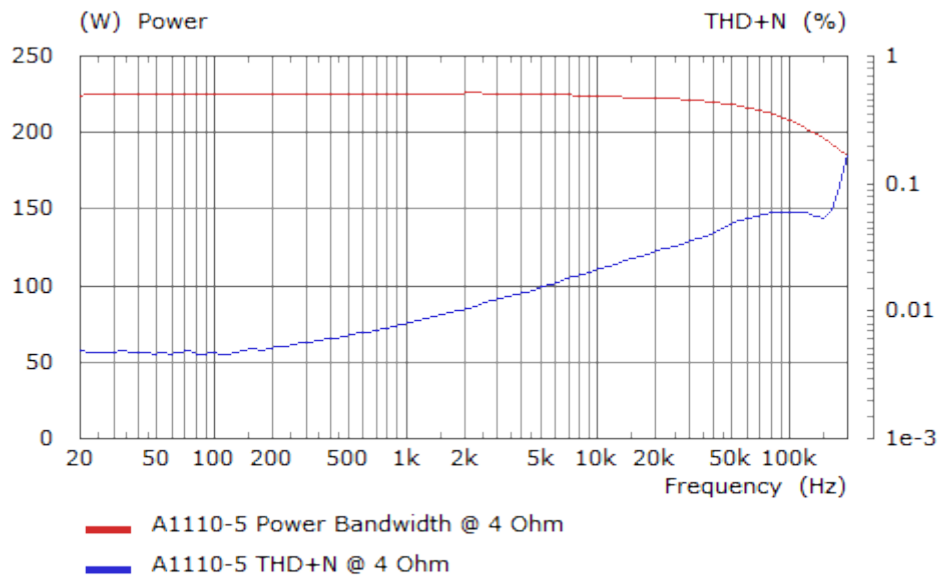

7.8 Pulse at 5 Ohm Load

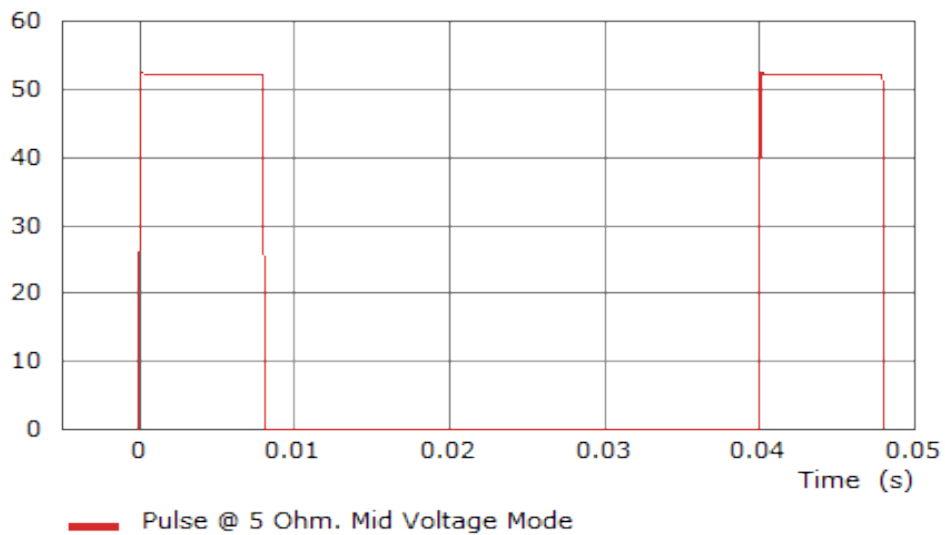



8 Block Diagram

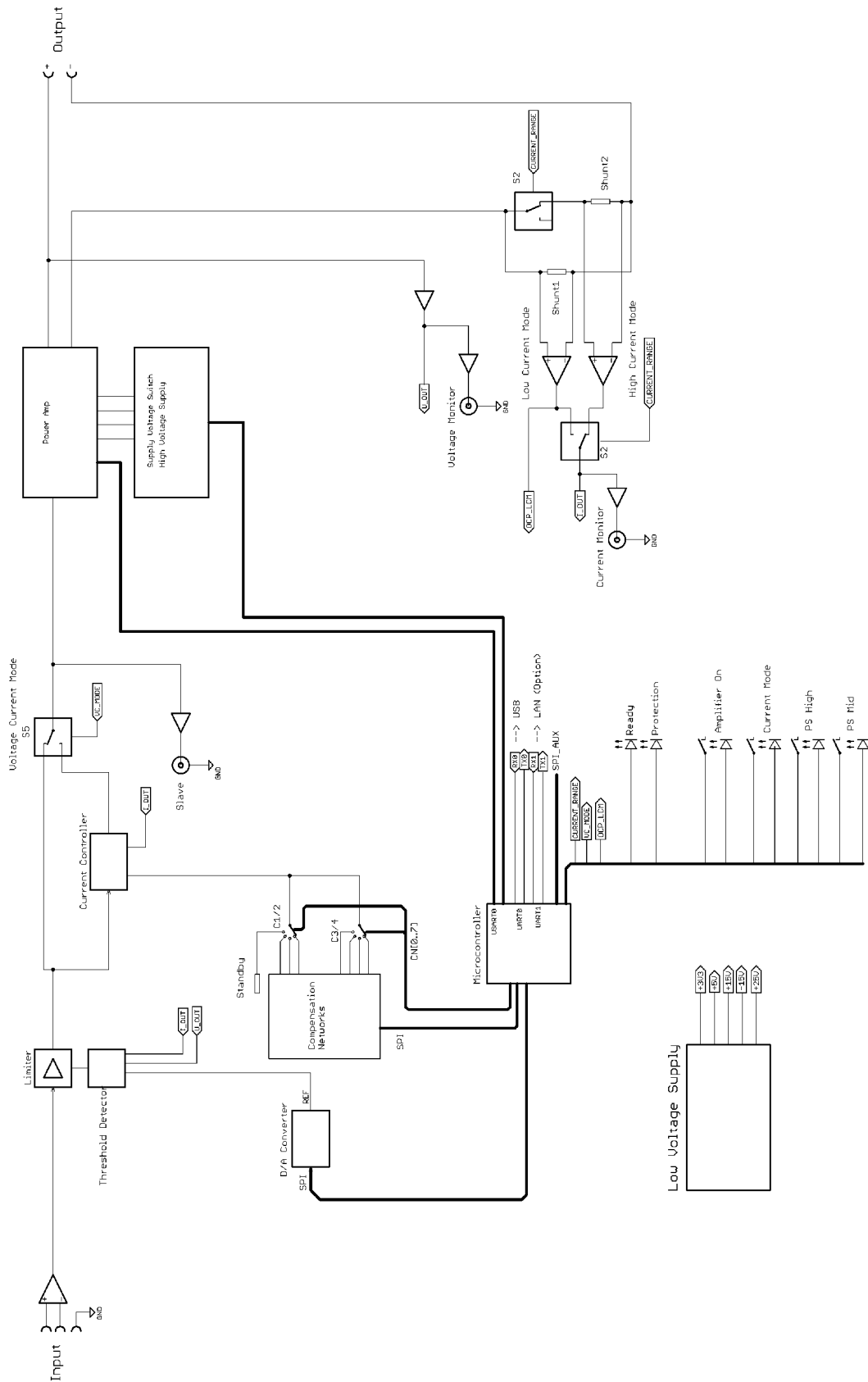



9 Product Options

The following product options are available at the time of placing the order. Upgrades of existing devices are not possible.

Article Name	Article Description
A1110-05-E	4-Quadrant Voltage and Current Amplifier
Option: Custom Current Amplifier	Additional compensation network for one specified load. The device is equipped with five general-purpose networks by default.
Option: 1-Channel Isolation Amplifier	For potential isolation of input and output
Option: 4-Channel Isolation Amplifier	For potential isolation of input and output
Option: Ethernet Interface	For connection to a computer (RJ45)
Option: Sensing	Adjustable voltage drop: 500 mV / 1 V / 2 V
Option: Internal Current Measurement	Internal current measurement by high-performance current transformer 0-400 A; Accuracy DC $\pm 0.1\%$; Output BNC socket, galvanically isolated from the amplifier
Option: Adjustable Output Resistance	R: 0 m Ω – 200 m Ω ; Resolution 1 m Ω ; Accuracy 0.5%
Option: Overvoltage Protection	For protection of amplifier outputs



10 Contact

Dr. Hubert GmbH
Dietrich-Benking-Str. 41
44805 Bochum - Germany
Tel. +49 234 970569-0
Fax. +49 234 970569-29
service@drhubert.de

Further information is available on our website www.drhubert.com.



11 Document History

Revision	Date	Changes
2.0	March 2020	First publication in new layout
2.1	July 2020	Change Low-Current-Monitor Gain Correction of some measurement tolerances
2.2	August 2020	Option-02 is now Option-10 for this device
3.0	April 2022	New housing